

VAG EKN® Butterfly Valves

DN 800 PN 6 / 10 / 16

Typ MT / MTG

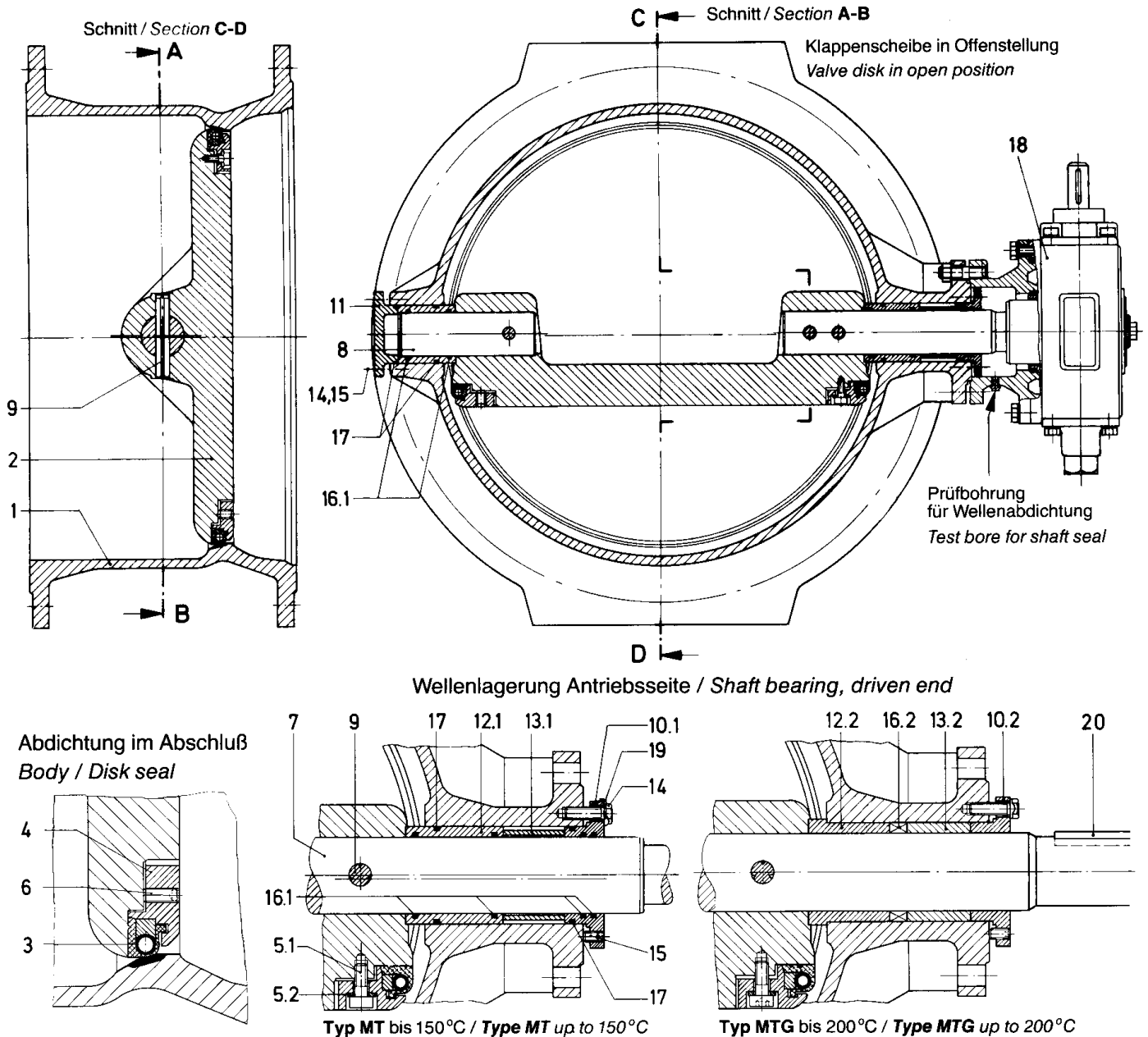

Teil Part	Benennung / Description	
1	Gehäuse	Body
2	Klappenscheibe	Disk
3	Profildichtring	Profile sealing ring
4	Haltering	Retaining ring
5.1	Zylinderschraube	Hex. socket head cap screw
5.2	Scheibe	Washer
6	Gewindestift	Hex. socket set screw
7	Welle, Antriebsseite	Shaft, driven end
8	Welle, Deckelseite	Shaft, free end
9	Zylinderkerbstift	Straight grooved pin
10.1	Lagerflansch, Typ MT	Bearing flange, Type MT
10.2	Lagerflansch, Typ MTG	Bearing flange, Type MTG

11	Lagerdeckel	Bearing cover
12.1	Lagerbuchse, Typ MT	Bearing bush, Type MT
12.2	Lagerbuchse, Typ MTG	Bearing bush, Type MTG
13.1	Distanzrohr, Typ MT	Spacer tube, Type MT
13.2	Distanzbuchse, Typ MTG	Spacer bush, Type MTG
14	Sechskantschraube	Hex. bolt
15	Gewindestift	Hex. socket set screw
16.1	O-Ring, Typ MT	O-Ring, Type MT
16.2	Packungsring, Typ MTG	Packing ring, Type MTG
17	O-Ring, Typ MT	O-Ring, Type MT
18	Schneckengetriebe kompl.	Worm gear unit
19	Sicherungsblech	Locking washer
20	Paßfeder	Parallel key

Spare parts list

Part	Description	piece	code number
DN 800 PN 6			
	SET 1 Profile sealing ring / Retaining ring	1	2-23-37144-800
3	Profile sealing ring	1	
4	Retaining ring	1	
5.1	Hex. Socket head cap screw	12	
6	Hex. Socket set screw	6	
	SET 2a Sealing MT	1	2-23-37144-801
3	Profile sealing ring	1	
16.1	O-ring	6	
17	O-ring	4	
	SET 2b Sealing MTG	1	2-23-37144-802
3	Profile sealing ring	1	
16.2	Packing ring	2	
7	Shaft, driven end	1	1-23-30597-551
8	Shaft, free end	1	1-23-27607-550
9	Rivet pin	3	1-23-33900-550
12	Bearing bush, MT	2	1-23-27410-180
12.1	Bearing bush, driven end MTG	1	1-23-29766-180
12.2	Bearing bush, free end MTG	1	1-23-29767-180
19	Locking washer	4	1-75-33091-492
DN 800 PN 10			
	SET 1 Profile sealing ring / Retaining ring	1	2-23-37138-800
3	Profile sealing ring	1	
4	Retaining ring	1	
5.1	Hex. Socket head cap screw	12	
6	Hex. Socket set screw	6	
	SET 2a Sealing MT	1	2-23-37138-801
3	Profile sealing ring	1	
16.1	O-ring	6	
17	O-ring	4	
	SET 2b Sealing MTG	1	2-23-37138-802
3	Profile sealing ring	1	
16.2	Packing ring	2	
7	Shaft, driven end	1	1-23-31174-550
8	Shaft, free end	1	1-23-27570-550
9	Rivet pin	4	1-23-33901-550
12	Bearing bush, MT	2	1-23-27525-180
12.1	Bearing bush, driven end MTG	1	1-23-28888-180
12.2	Bearing bush, free end MTG	1	1-23-28889-180
19	Locking washer	4	1-75-33091-494
DN 800 PN 16			
	SET 1 Profile sealing ring / Retaining ring	1	2-23-37139-800
3	Profile sealing ring	1	
4	Retaining ring	1	
5.1	Hex. Socket head cap screw	12	
6	Hex. Socket set screw	6	
	SET 2a Sealing MT	1	2-23-37139-801
3	Profile sealing ring	1	
16.1	O-ring	6	
17	O-ring	4	
	SET 2b Sealing MTG	1	2-23-37139-802
3	Profile sealing ring	1	
16.2	Packing ring	2	
7	Shaft, driven end	1	1-23-33736-550
8	Shaft, free end	1	1-23-27627-550
9	Rivet pin	4	1-23-35496-550
12	Bearing bush, MT	2	1-23-27527-180
12.1	Bearing bush, driven end MTG	1	1-23-33734-180
12.2	Bearing bush, free end MTG	1	1-23-33734-180
19	Locking washer	4	1-75-33091-495



VAG-Armaturen GmbH
 Carl-Reuther-Straße 1
 D-68305 Mannheim
 P.O.B. 31 05 48
 D-68265 Mannheim
 Phone (0621) 749 - 0
 Fax (0621) 749 - 2153
 Internet: www.vag-armaturen.com

© by VAG-Armaturen GmbH